

The
Favilla 





our mission

Around the campfire, we are reminded that we are part of something larger than ourselves, a community bound together by the ties of friendship, love, and shared experiences. As the Favilla family, we invite you to gather around our campfire, and let the magic of the flames transport you to a realm where time stands still and the worries of the world melt away. Let the stories flow, the laughter echo, and the bonds of friendship grow stronger. For in the light of the campfire, we are truly alive.



CONTENT

FUMO	6-15
HUBO	16-19
VEDEM	20-23
FIREBOX	24-27
CAMPSTAR	28-31
TRICA	32-35
CUMBO	36-39
NAICAM	40-43
TRIWOOD	44-47
ACCESSORIES	48-49

FUMO

Bring the barbecue to your camping tent!



camping materials



thefavilla.com

MEDIUM

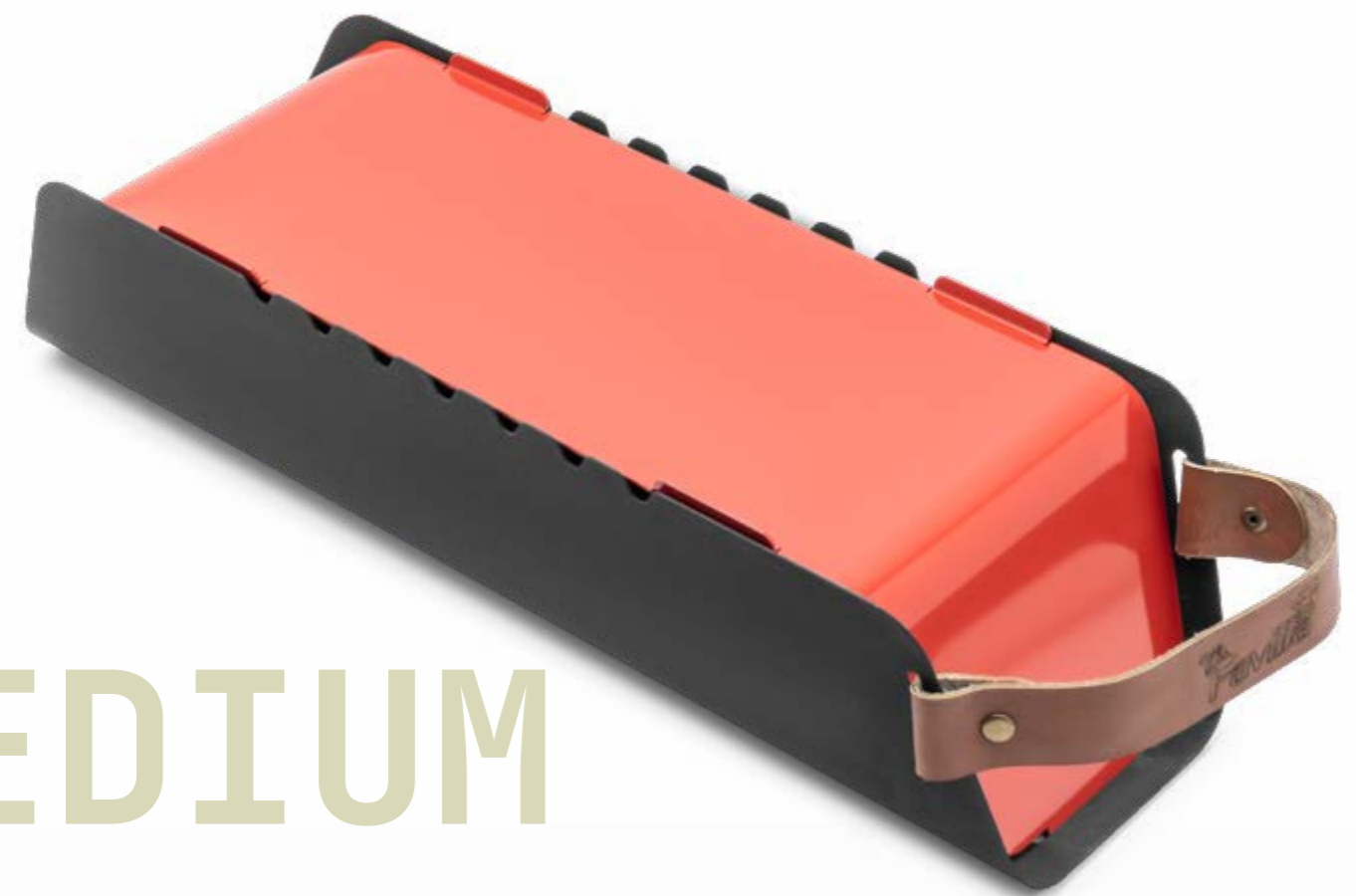

LARGE



Technical Specifications

Fumo is a well disassembled product.

You can easily carry it wherever you want with 100% genuine leather handle.

It consists of 6 parts in total.

All kinds of meat, vegetables and fishes could be cooked on it.

It burns properly, does not suffocate and maintains the heat.

Fumo is delivered with its protective cloth bag.

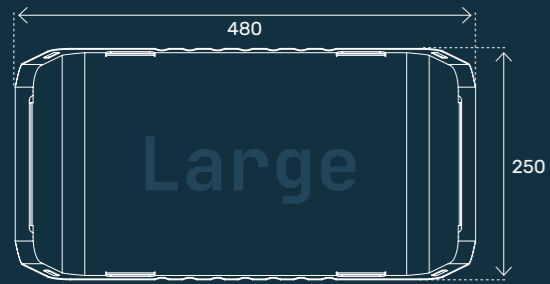

HUBO

Carry your campfire in your backpack!



Technical Specifications

Hubo is a well disassembled product.

All kinds of meat, vegetables and fishes could be cooked on it.

It consists of 3 parts: fire chamber, ash chamber and cooking chamber.

It can be installed easily and it locks itself when installed.

There are skewer attachment sections on it.

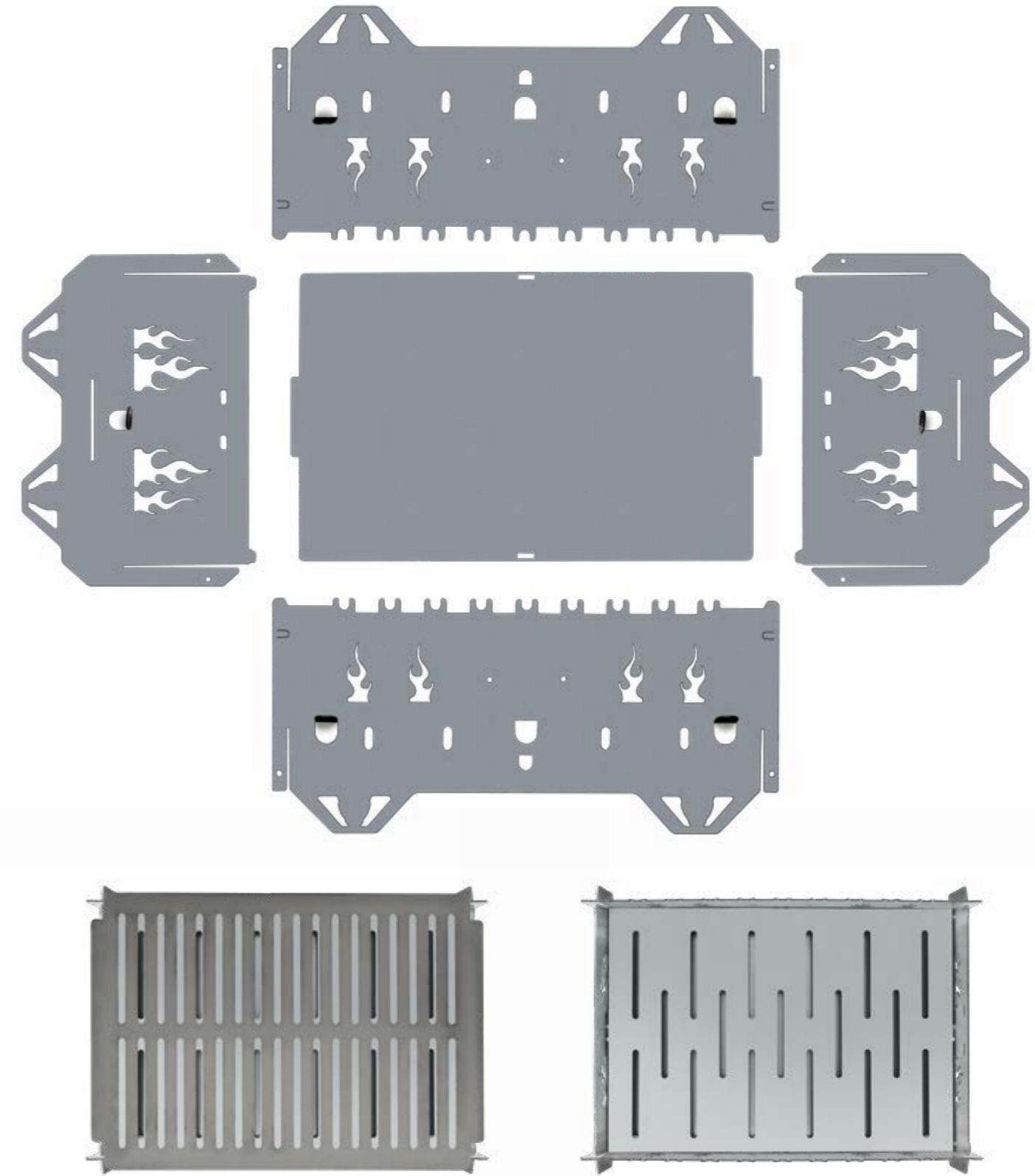
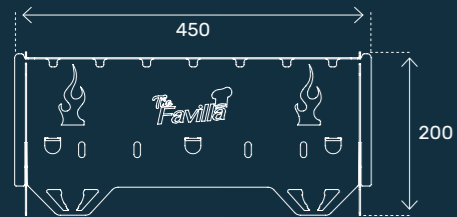
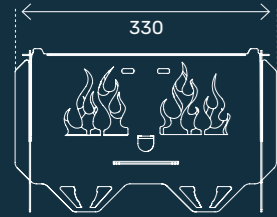
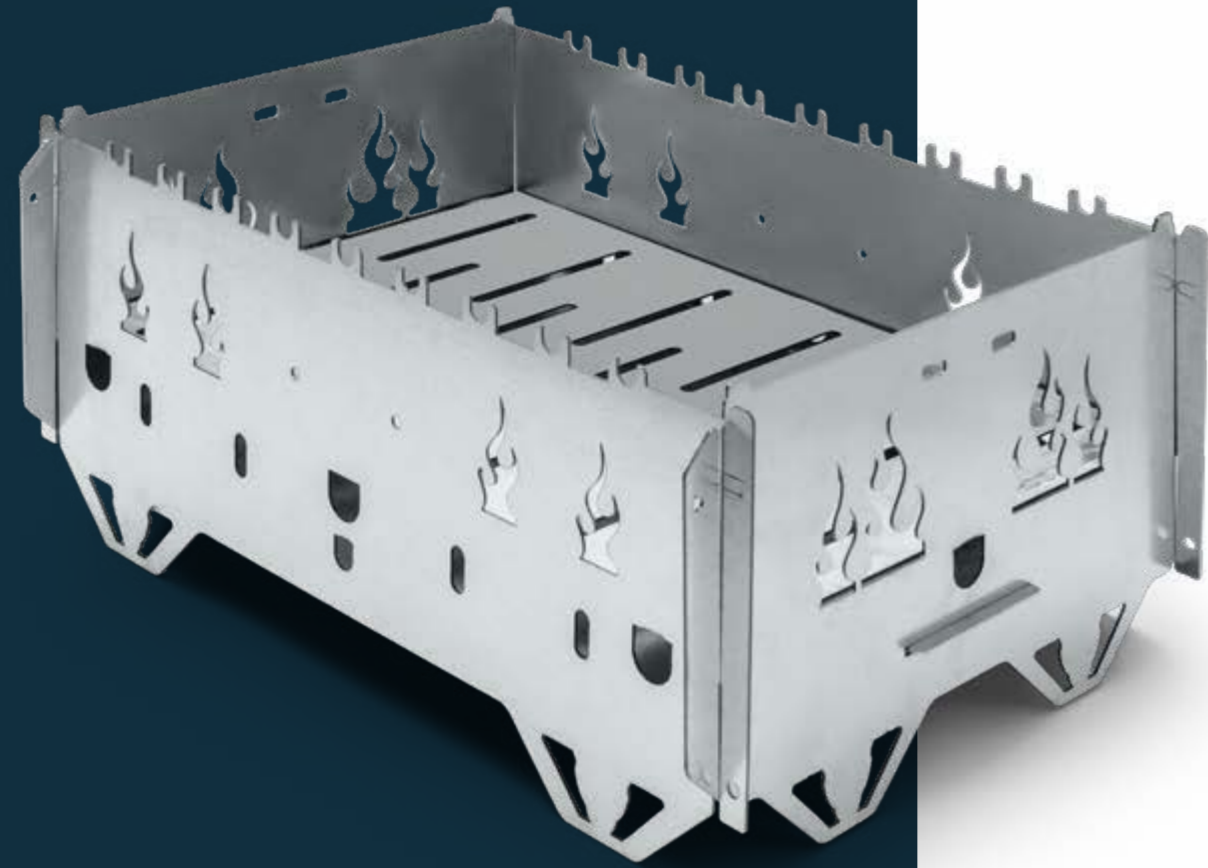

VEDEM

Unpack the adventure with
disassembled Vedem!



thefavilla.com

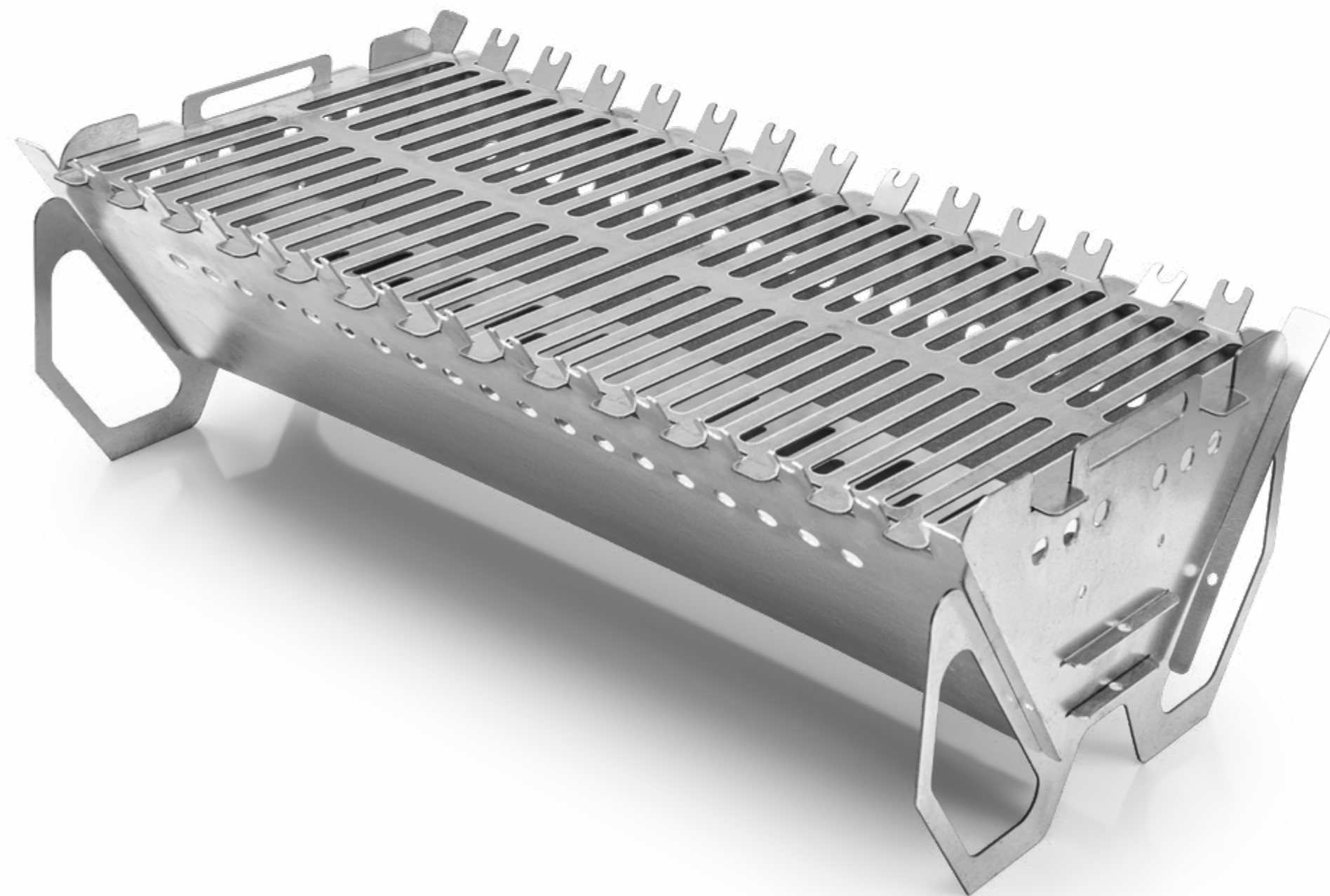

Technical Specifications

Hubo is a well disassembled product.

It consists of 3 parts: fire chamber, ash chamber and cooking chamber.

It can be assembled easily and it locks itself when assembled.

All kinds of meat, vegetables and fishes could be cooked on it.

There are skewer attachment sections on it.

Vedem is delivered in its own cloth bag.

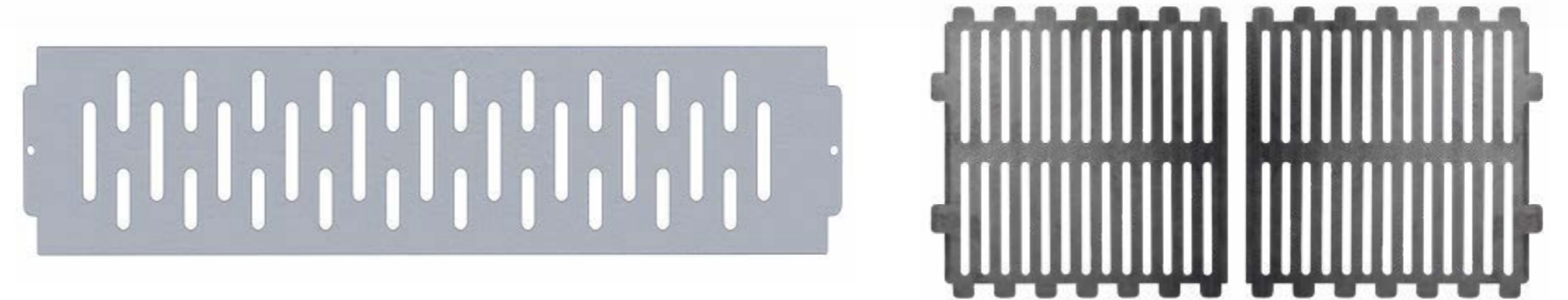
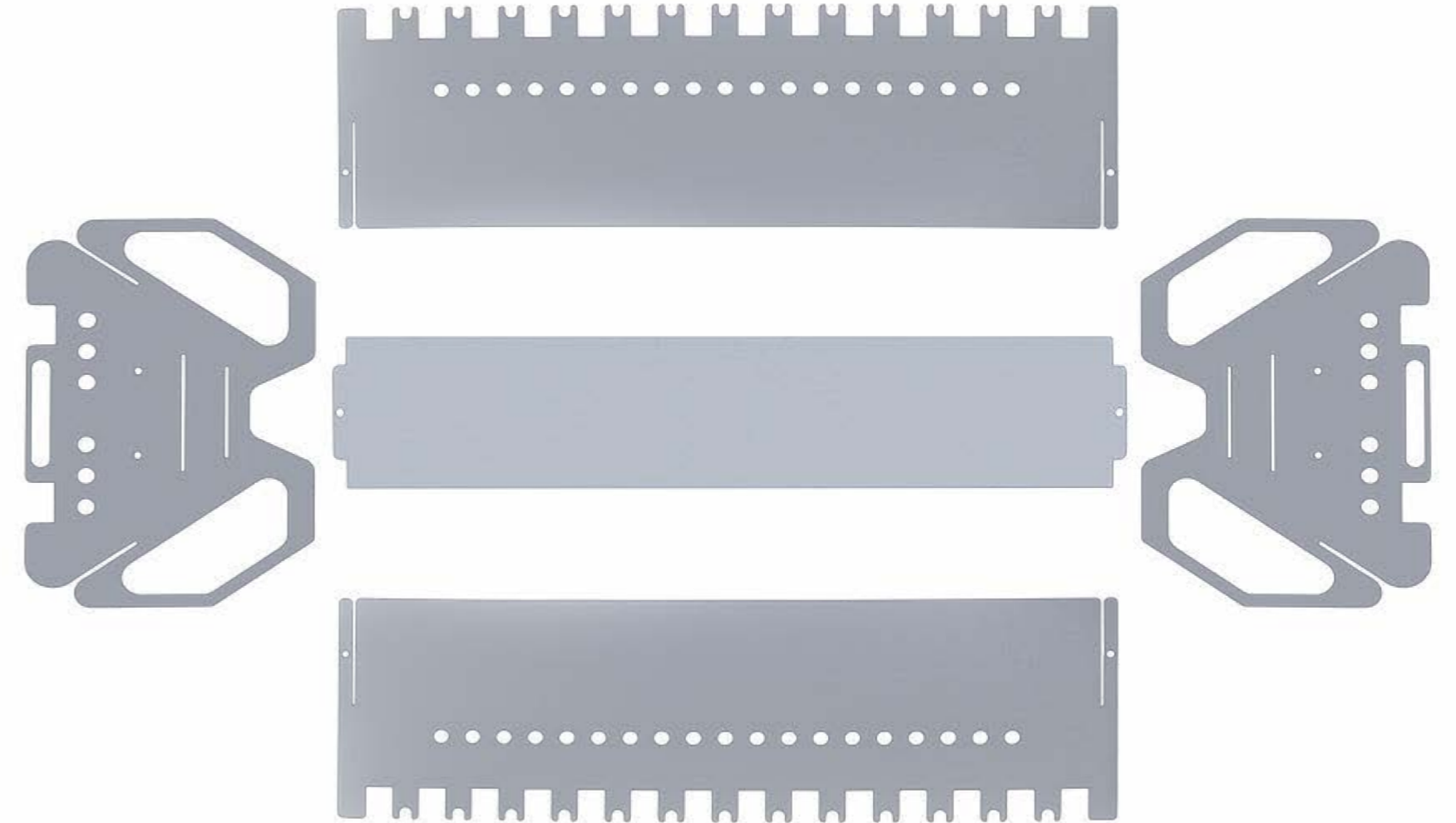
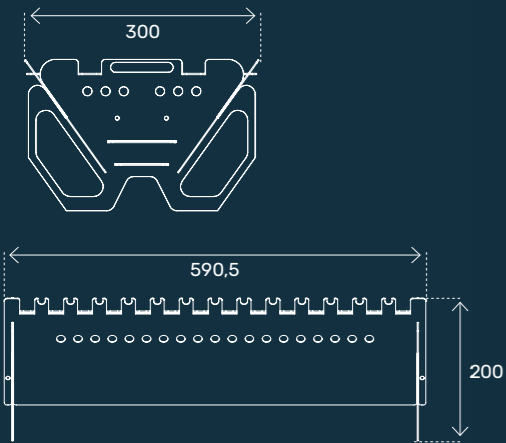
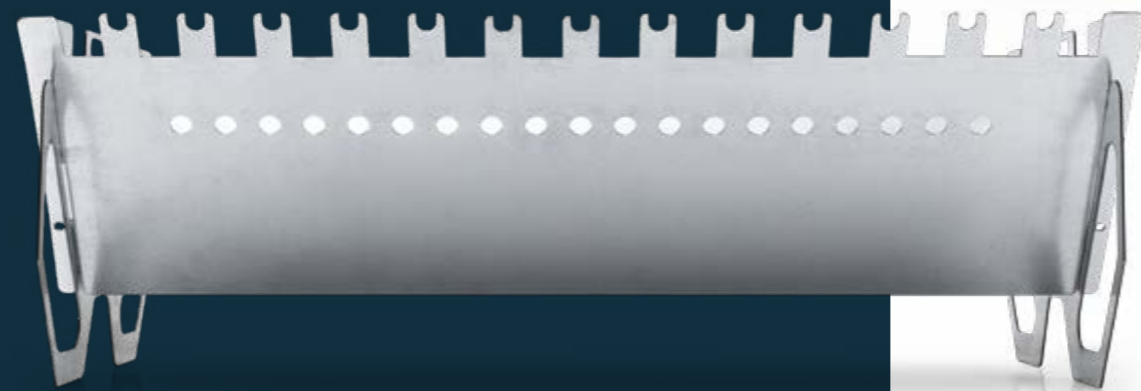
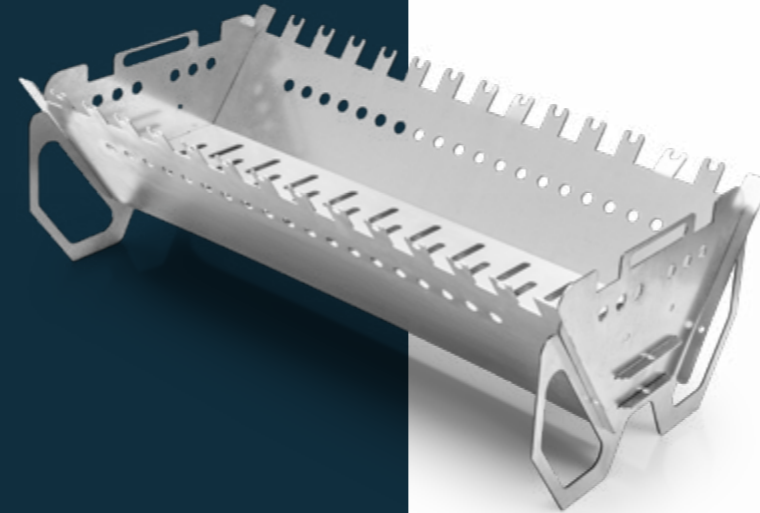

FIREBOX

Unleash the adventure wherever you go with foldable Firebox!



Technical Specifications

Since it is foldable, it can be carried easily and it occupies a little space in your camping backpack.

Cooking can be made on the product itself, or also can be made with pans, teapots, etc. on the product.

There are skewer attachment sections on it.

Ashes are automatically extracted from the bottom of the product.

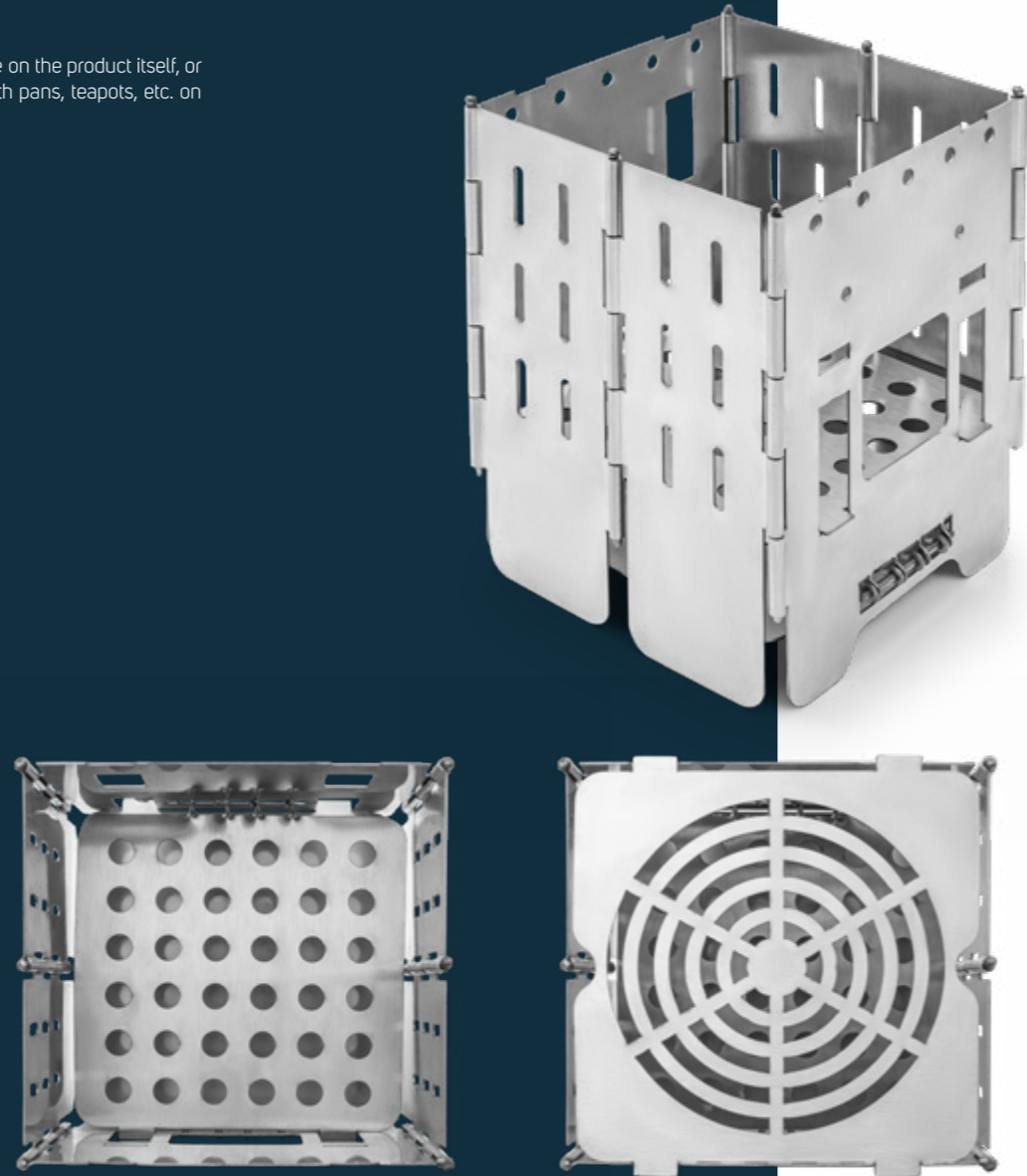
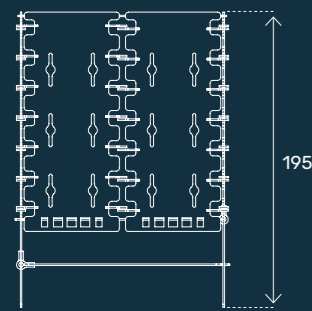
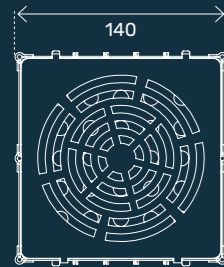

CAMPSTAR

Deconstruct the ordinary, and assemble the extraordinary with our reimagined campfire experience!

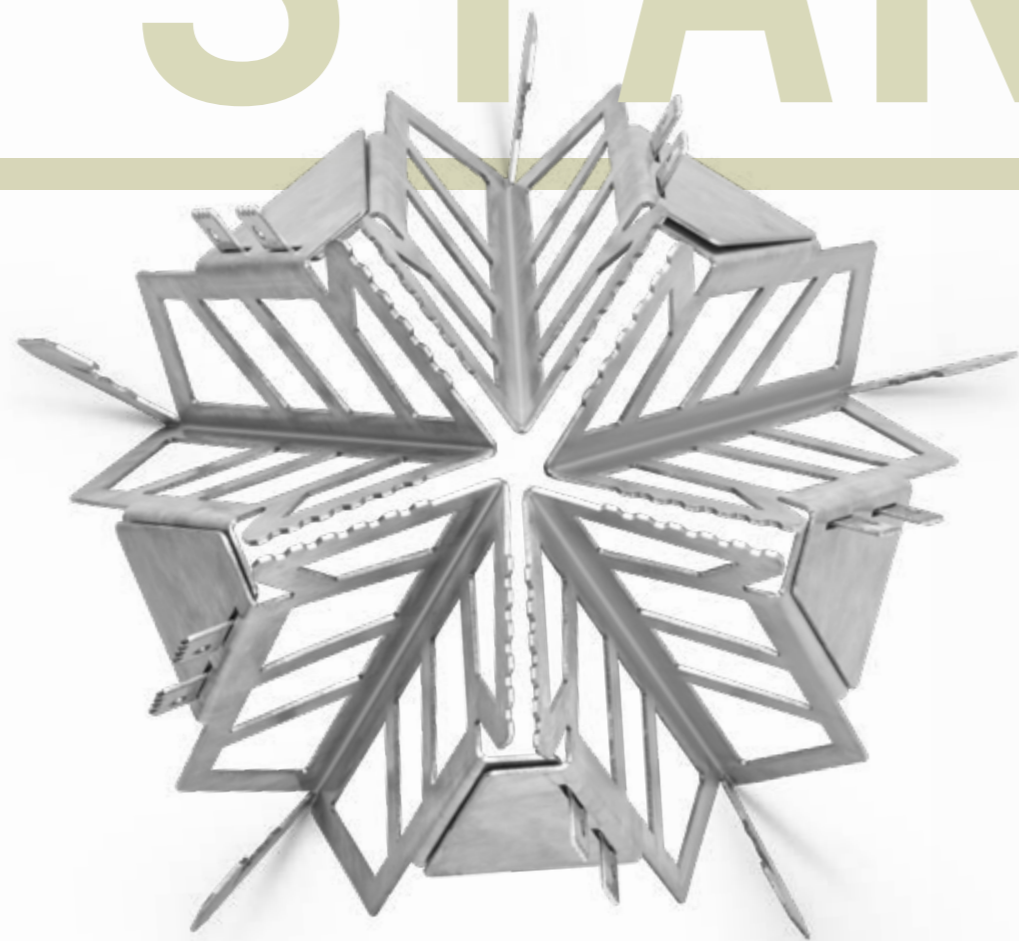

thefavilla.com



Technical Specifications

Campstar consists of five symmetrical parts.

It is delivered in its own cloth bag.

After the product is interlocked, you can place the log pieces on and start the fire.

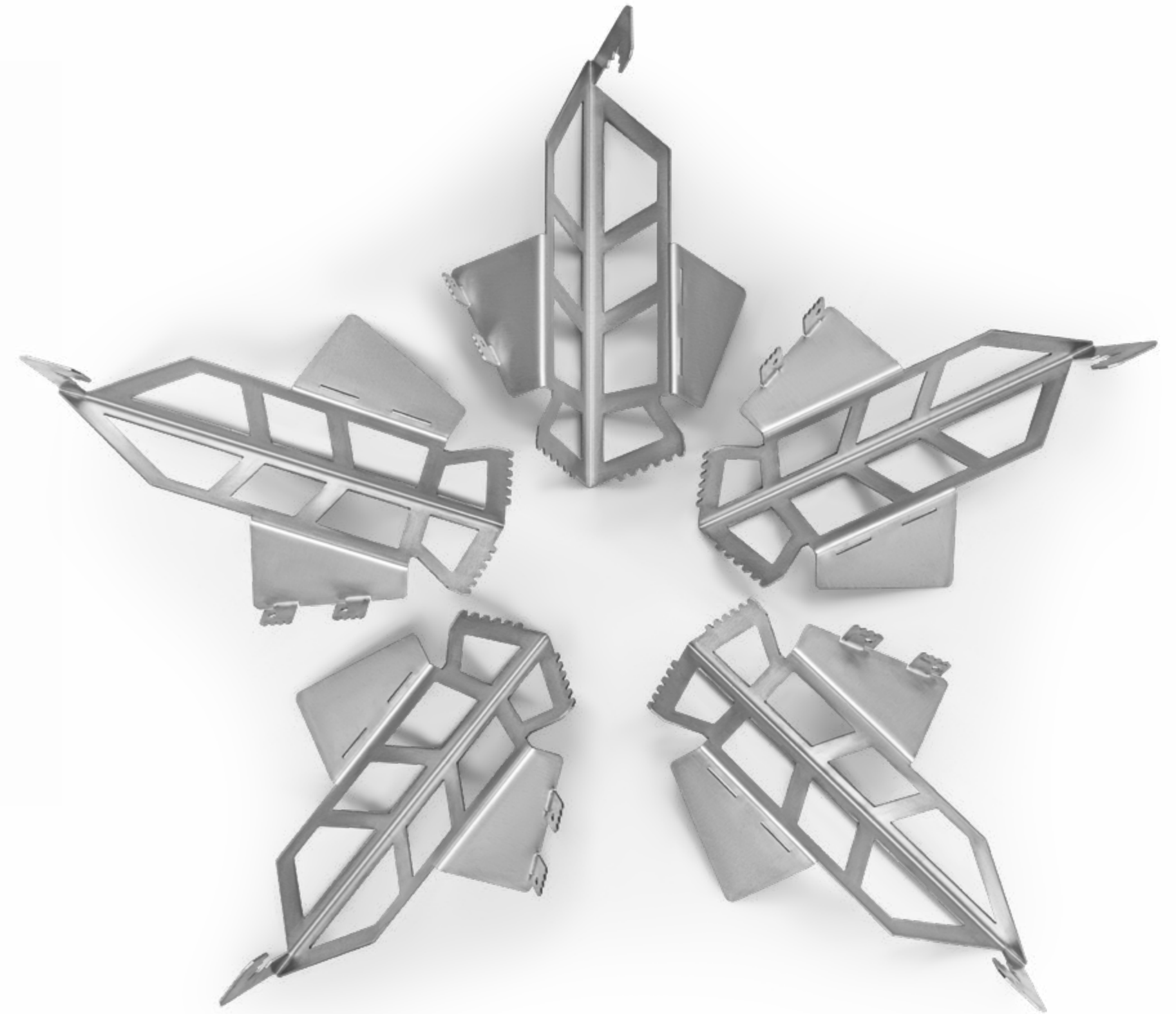
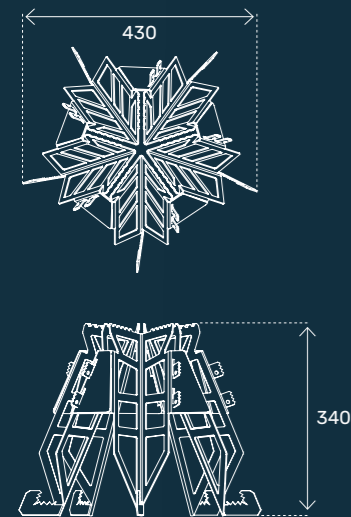

TRICA

Experience the warmth of simplicity, ignite, enjoy, and gather around effortlessly.



Technical Specifications

Trica consists of 3 legs, cooking chamber and carrying bag.

The legs have the ability to be disassembled and mounted.

The legs are locked well in assembling.

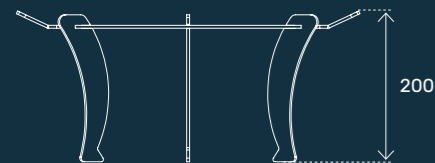
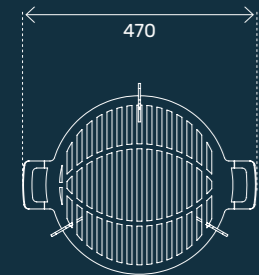

CUMBO

Experience the radiant allure of our portable campfire with style and warmth.



CUMBO

Technical Specifications

There is a divided section for brewing tea and a separate section for sealing meat on the Cumbo.

It has the feature of adjusting the height according to the fire temperature.

Cumbo can be used in any environment where it can be easily dug into the soil.

Suspension shaft, skewer mounting apparatus, shaft mounting apparatus and carrying bag compose the Cumbo set.

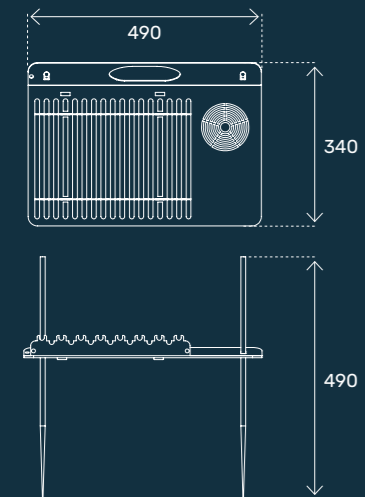

camping materials

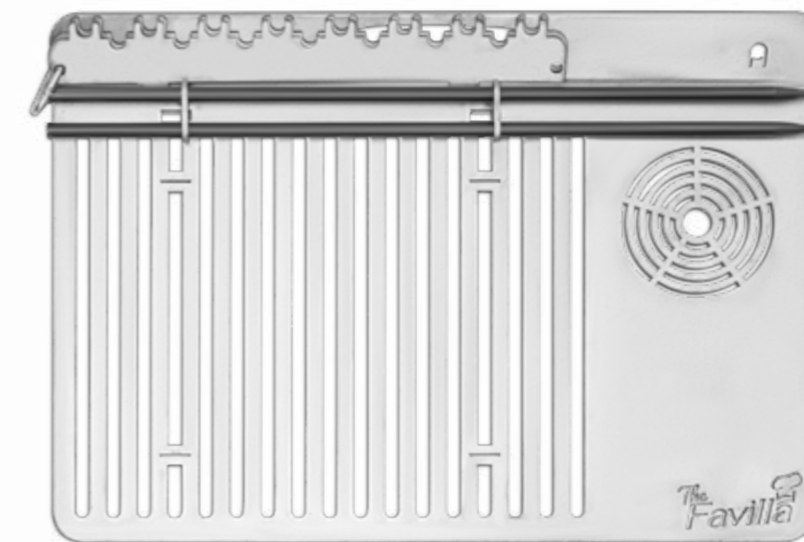
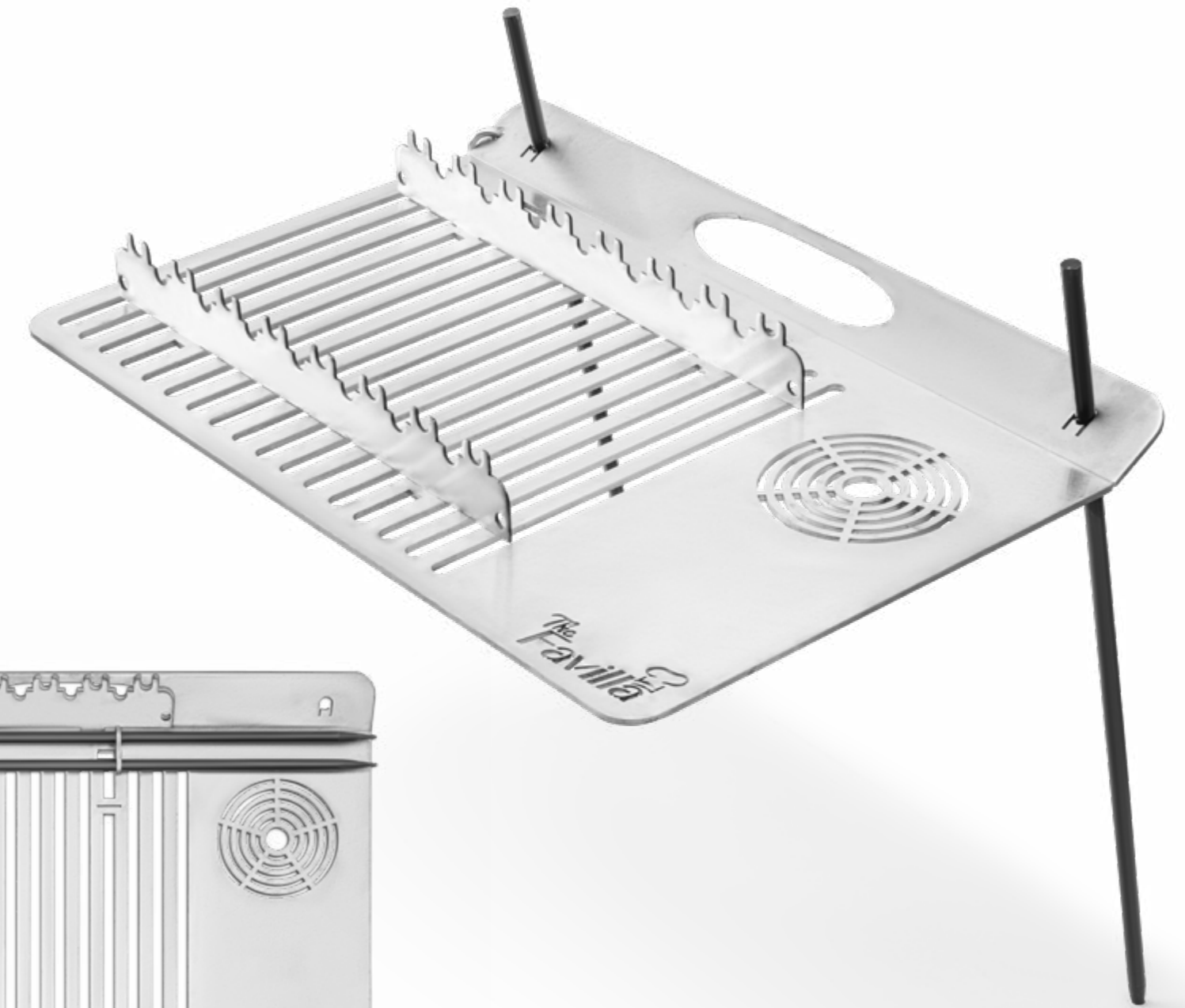

thefavilla.com

NAICAM

Immerse yourself in traditional warmth with the portable Naicam!



NAICAM

Technical Specifications

Naicam is made of stainless steel.

You can burn Naicam as you wish by mounting it on a shredded log.

Supplied with four nails and carrying case.

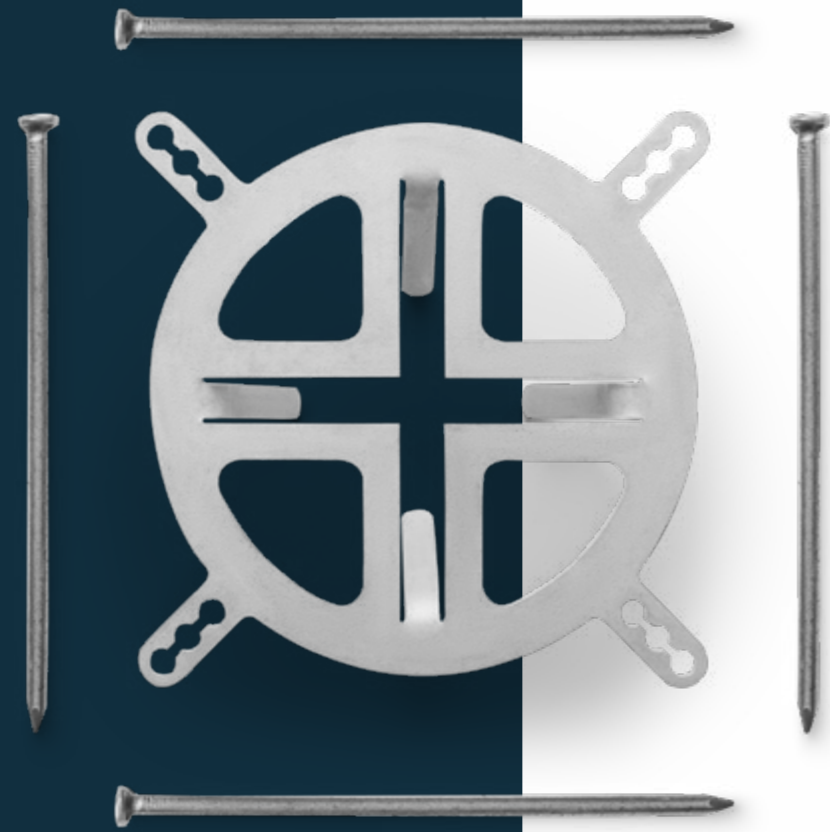
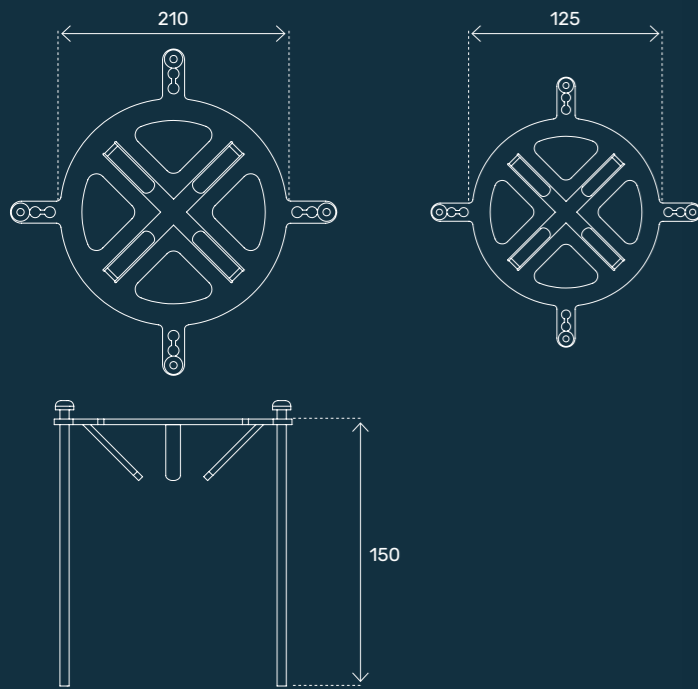

camping materials



thefavilla.com

TRIWOOD

Discover practicality with
Triwood!



Technical Specifications

Triwood consists of carrying bag, chain, fixing apparatus, hanging apparatus and the main part.

You can brew coffee, tea, etc. or you can cook by hanging.

You can make a hearth at the height you want from 3 different branches you obtain in nature.

The chain can be adjusted to the size you want.

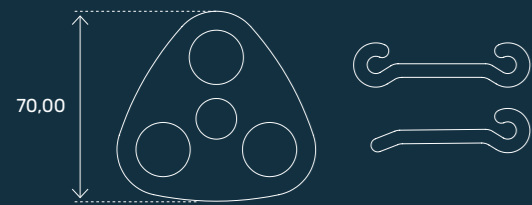

ACCESSORIES



Pizza Peel



PSB-2



PSB-1



PSB-3



SB-1



SB-2



SB-3



SB-4



SB-5



SB-6



SB-7



SB-8



*All of the information contained in this catalog contains the latest product information.
Our company reserves the right to change the information in this catalog without notice when necessary.
Our company cannot be held responsible for all kinds of color and typographic errors that may occur in printing.*

The Favilla

www.thefavilla.com
info@thefavilla.com

+90 552 576 38 90
+90 352 311 34 07

Industrial Zone 9. St. No:27
Kayseri / TURKEY

